

# VZ3184R IR-MP PZFI

**【SPECIFICATIONS】** 2.7X motorized zoom lens for 4Mega-Pixel

Image Size : 1

Focal Length : 31~84mm  
 Maximum Relative Aperture : 1:2.6  
 Iris : F2.6~Close (No F drop)  
 Zoom Ratio : 2.7X  
 Angle of View : 23.6×17.7 deg. at 31mm  
 8.7× 6.5 deg. at 84mm  
 Image Size : 12.8×9.6mm(φ16mm)  
 Minimum Object Distance : 7m(From Front Vertex)  
 Resolution : Corresponding to 5.5μm  
 Optical Back Focal Distance : 23.29mm(In Air)  
 Frange Back : 17.526mm

Flange Back : 17.526mm  
 Operation : Zoom : Motorized (DC±6.4V, Max45mA)  
 Potentiometer : 5kΩ  
 Focus : Motorized (DC±6.4V, Max45mA)  
 Potentiometer : 5kΩ  
 Iris : Motorized (DC±6.4V, Max45mA)  
 Potentiometer : 5kΩ  
 Operating Temperature : -10~+50°C  
 Mount : C-Mount (Adjustable Lens Position)  
 Filter Size : 62mm P0.75  
 Size : 80×80.5×114.8mm  
 Weight : Approx. 710g

**【COMPOSITION】**

- Lens.....1
- Lens Cap.....1
- Dust Cap.....1

**【DIMENSIONS】**

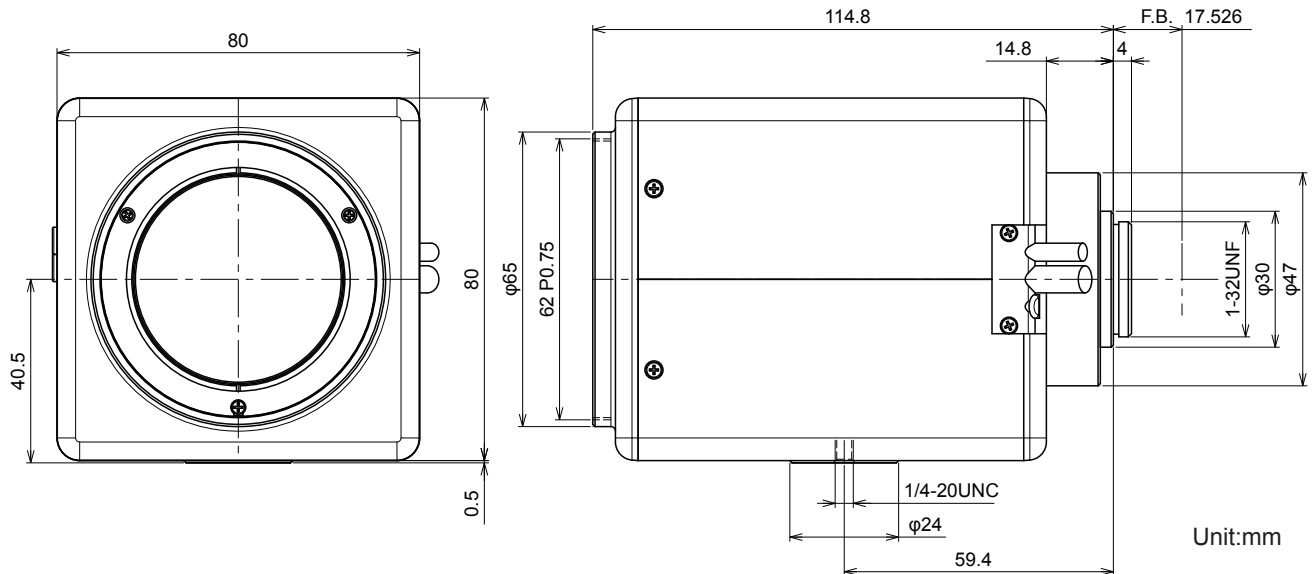

**【CIRCUIT DIAGRAM】**

